



16mm Metal Shaft Rotary Potentiometer (16mm 金屬軸旋轉電位器)

R16K1



Part Number

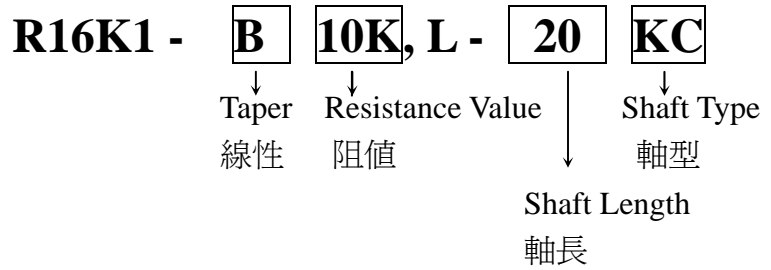

Dimensions 規格尺寸

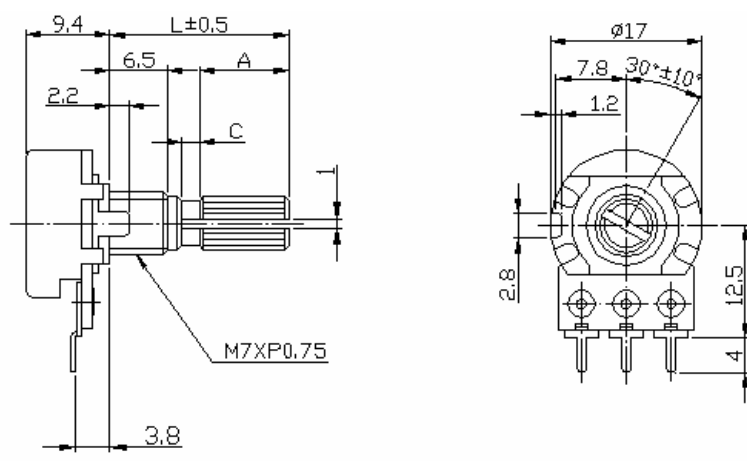

Shaft Type 軸型

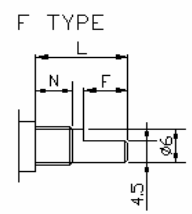
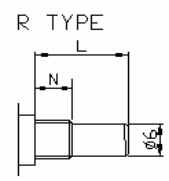
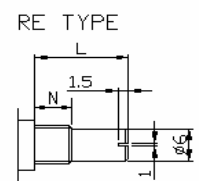
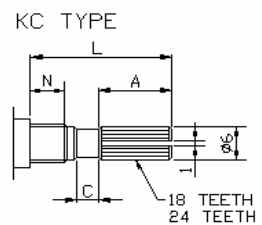
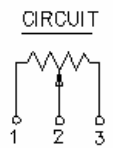
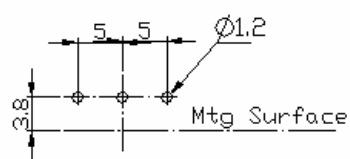

Ni6.5m/m

SHAFT-TYPE	L	10	15	20	25	30	35	40
KC	A	2.2	6	10	12	12	12	12
	C	0.5	1	2	2	4	4	4
F	F	2.5	7	12	12	12	12	12
R,RE	L	10	15	20	25	30	35	40



16mm Metal Shaft Rotary Potentiometer (16mm 金屬軸旋轉電位器)

Electrical Characteristics 電氣特性

Total Resistance 總阻值	500Ω ~ 2MΩ				
Total Resistance Tolerance 總阻值誤差	± 20% (More than 1MΩ± 30%)				
Resistance Taper 線性	A. B. C. D. W. Taper				
Resistance Taper Characteristics 阻值變化特性範圍	A50%	B50%	C50%	D50%	W50%
	15-25%	40-60%	75-85%	2-15%	45-55%
Rated Power 定格電力	B Taper: 0.2 W; Other Tapers: 0.1 W				
Max. Operating Voltage 最高使用電壓	B Taper: AC200V ; Other Tapers: AC150V				
Residual Resistance 殘留阻值	R ≥ 250KΩ 0.1%				
	250KΩ > R > 10KΩ		10Ω Max. (between Term. 1, 2)		
Noise 雜音	10KΩ ≥ R		10Ω Max. (between Term. 2, 3)		
	47 mV max.				
Insulation Resistance 絕緣阻抗	DC 500V 100MΩ				
Withstand Voltage 耐電壓	1 minute AC 500V				
Rotational Life 旋轉壽命	15,000 Cycles				
Switch Life 開關壽命	10,000 Cycles				

Mechanical Characteristics 機械特性

Total Rotational Angle 全迴轉角度	300° ± 5°
Rotational Torque 迴轉扭力	30~200gf.cm
Pull-Push Strength 推拉強度	7 kgf.cm max./3 minute.
Center Click Torque C.C. 扭力	150~350g.cm
Click Position C.C 位置	Center 11/21/31/41 Detents
Solder Heat Resistance 銲錫耐熱性	300°C, 3s (Only For Hand-Soldering)
Remark 備註	Shaft: Cast Iron (Aluminum Zinc) Bushing Material: cast iron