

## FEATURES

- Continuous Short-Circuit Protection
- Wide Common-Mode and Differential Voltage Ranges
- No Frequency Compensation Required
- Low Power Consumption
- No Latch-Up
- Unity-Gain Bandwidth . . . 3 MHz Typ
- Gain and Phase Match Between Amplifiers
- Low Noise . . . 8 nV/ $\sqrt{\text{Hz}}$  Typ at 1 kHz

D, DGK, P, PS, OR PW PACKAGE  
(TOP VIEW)

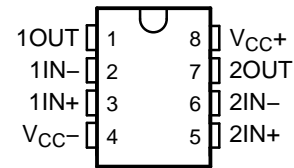

## DESCRIPTION/ORDERING INFORMATION

The RC4558 device is a dual general-purpose operational amplifier, with each half electrically similar to the  $\mu\text{A}741$ , except that offset null capability is not provided.

The high common-mode input voltage range and the absence of latch-up make this amplifier ideal for voltage-follower applications. The device is short-circuit protected, and the internal frequency compensation ensures stability without external components.

### ORDERING INFORMATION

$T_A$	PACKAGE <sup>(1)</sup>		ORDERABLE PART NUMBER	TOP-SIDE MARKING
0°C to 70°C	MSOP/VSSOP – DGK	Reel of 2500	RC4558DGKR	YR_ <sup>(2)</sup>
	PDIP – P	Tube of 50	RC4558P	RC4558P
	SOIC – D	Tube of 75	RC4558D	RC4558
		Reel of 2500	RC4558DR	
	SOP – PS	Reel of 2000	RC4558PSR	R4558
	TSSOP – PW	Tube of 150	RC4558PW	R4558
Reel of 2000		RC4558PWR		
–40°C to 85°C	MSOP/VSSOP – DGK	Reel of 2500	RC4558IDGKR	YS_ <sup>(2)</sup>
	PDIP – P	Tube of 50	RC4558IP	RC4558IP
	SOIC – D	Tube of 75	RC4558ID	R4558I
		Reel of 2500	RC4558IDR	
	TSSOP – PW	Tube of 150	RC4558IPW	R4558I
		Reel of 2000	RC4558IPWR	

(1) Package drawings, standard packing quantities, thermal data, symbolization, and PCB design guidelines are available at [www.ti.com/sc/package](http://www.ti.com/sc/package).

(2) The actual top-side marking has one additional character that designates the assembly/test site.



Please be aware that an important notice concerning availability, standard warranty, and use in critical applications of Texas Instruments semiconductor products and disclaimers thereto appears at the end of this data sheet.

# RC4558 DUAL GENERAL-PURPOSE OPERATIONAL AMPLIFIER

SLOS073E—MARCH 1976—REVISED FEBRUARY 2006

## SCHEMATIC (EACH AMPLIFIER)

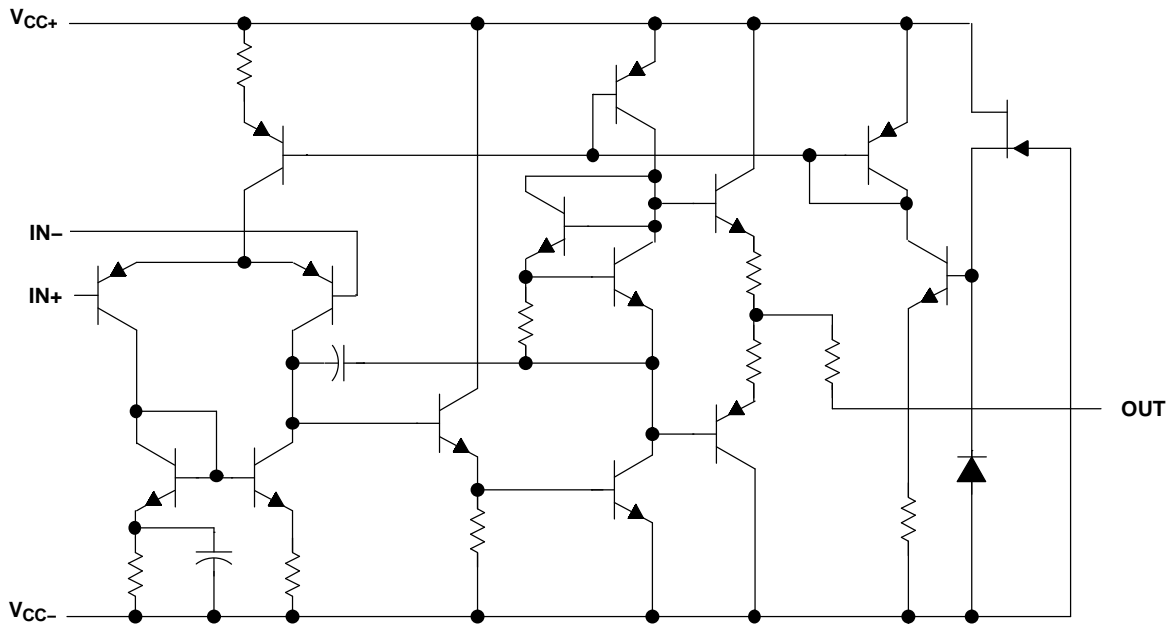

### Absolute Maximum Ratings<sup>(1)</sup>

over operating free-air temperature range (unless otherwise noted)

		MIN	MAX	UNIT
$V_{CC+}$	Supply voltage <sup>(2)</sup>		18	V
$V_{CC-}$			-18	
$V_{ID}$	Differential input voltage <sup>(3)</sup>		±30	V
$V_I$	Input voltage (any input) <sup>(2)(4)</sup>		±15	V
Duration of output short circuit to ground, one amplifier at a time <sup>(5)</sup>			Unlimited	
$\theta_{JA}$	Package thermal impedance <sup>(6)(7)</sup>	D package	97	°C/W
		DGK package	172	
		P package	85	
		PS package	95	
		PW package	149	
$T_J$	Operating virtual junction temperature		150	°C
$T_{stg}$	Storage temperature range	-65	150	°C

- (1) Stresses beyond those listed under *Absolute Maximum Ratings* may cause permanent damage to the device. These are stress ratings only, and functional operation of the device at these or any other conditions beyond those indicated under *Recommended Operating Conditions* is not implied. Exposure to absolute-maximum-rated conditions for extended periods may affect device reliability.
- (2) All voltage values, unless otherwise noted, are with respect to the midpoint between  $V_{CC+}$  and  $V_{CC-}$ .
- (3) Differential voltages are at IN+ with respect to IN-.
- (4) The magnitude of the input voltage must never exceed the magnitude of the supply voltage or 15 V, whichever is less.
- (5) Temperature and/or supply voltages must be limited to ensure that the dissipation rating is not exceeded.
- (6) Maximum power dissipation is a function of  $T_J$  (max),  $\theta_{JA}$ , and  $T_A$ . The maximum allowable power dissipation at any allowable ambient temperature is  $P_D = (T_J \text{ (max)} - T_A)/\theta_{JA}$ . Operating at the absolute maximum  $T_J$  of 150°C can affect reliability.
- (7) The package thermal impedance is calculated in accordance with JESD 51-7.

### Recommended Operating Conditions

		MIN	MAX	UNIT	
$V_{CC+}$	Supply voltage	5	15	V	
$V_{CC-}$		-5	-15		
$T_A$	Operating free-air temperature	RC4558	0	70	°C
		RC4558I	-40	85	

# RC4558 DUAL GENERAL-PURPOSE OPERATIONAL AMPLIFIER

SLOS073E—MARCH 1976—REVISED FEBRUARY 2006

## Electrical Characteristics

at specified free-air temperature,  $V_{CC+} = 15\text{ V}$ ,  $V_{CC-} = -15\text{ V}$

PARAMETER		TEST CONDITIONS <sup>(1)</sup>	$T_A$ <sup>(2)</sup>	MIN	TYP	MAX	UNIT
$V_{IO}$	Input offset voltage	$V_O = 0$	25°C	0.5	6		mV
			Full range			7.5	
$I_{IO}$	Input offset current	$V_O = 0$	25°C	5	200		nA
			Full range			300	
$I_{IB}$	Input bias current	$V_O = 0$	25°C	150	500		nA
			Full range			800	
$V_{ICR}$	Common-mode input voltage range		25°C	±12	±14		V
$V_{OM}$	Maximum output voltage swing	$R_L = 10\text{ k}\Omega$	25°C	±12	±14		V
			Full range	±10	±13		
				±10			
$A_{VD}$	Large-signal differential voltage amplification	$R_L \geq 1\text{ k}\Omega$ , $V_O = \pm 10\text{ V}$	25°C	20	300		V/mV
			Full range	15			
$B_1$	Unity-gain bandwidth		25°C	3			MHz
$r_i$	Input resistance		25°C	0.3	5		M $\Omega$
CMRR	Common-mode rejection ratio		25°C	70	90		dB
$k_{SVS}$	Supply-voltage sensitivity ( $\Delta V_{IO}/\Delta V_{CC}$ )	$V_{CC} = \pm 15\text{ V}$ to $\pm 9\text{ V}$	25°C	30	150		$\mu\text{V/V}$
$V_n$	Equivalent input noise voltage (closed loop)	$A_{VD} = 100$ , $R_S = 100\ \Omega$ , $f = 1\text{ kHz}$ , $BW = 1\text{ Hz}$	25°C	8			$\text{nV}/\sqrt{\text{Hz}}$
$I_{CC}$	Supply current (both amplifiers)	$V_O = 0$ , No load	25°C	2.5	5.6		mA
			$T_A$ min	3	6.6		
			$T_A$ max	2.3	5		
$P_D$	Total power dissipation (both amplifiers)	$V_O = 0$ , No load	25°C	75	170		mW
			$T_A$ min	90	200		
			$T_A$ max	70	150		
$V_{O1}/V_{O2}$	Crosstalk attenuation	Open loop	$R_S = 1\text{ k}\Omega$ , $f = 10\text{ kHz}$	25°C	85		dB
		$A_{VD} = 100$			105		

(1) All characteristics are measured under open-loop conditions with zero common-mode input voltage, unless otherwise specified.

(2) Full range is 0°C to 70°C for RC4558 and -40°C to 85°C for RC4558I.

## Operating Characteristics

$V_{CC+} = 15\text{ V}$ ,  $V_{CC-} = -15\text{ V}$ ,  $T_A = 25^\circ\text{C}$

PARAMETER	TEST CONDITIONS			MIN	TYP	MAX	UNIT
$t_r$	Rise time	$V_I = 20\text{ mV}$ ,	$R_L = 2\text{ k}\Omega$ , $C_L = 100\text{ pF}$		0.13		ns
	Overshoot	$V_I = 20\text{ mV}$ ,	$R_L = 2\text{ k}\Omega$ , $C_L = 100\text{ pF}$		5		%
SR	Slew rate at unity gain	$V_I = 10\text{ V}$ ,	$R_L = 2\text{ k}\Omega$ , $C_L = 100\text{ pF}$	1.1	1.7		V/ $\mu\text{s}$

**TYPICAL CHARACTERISTICS**

**SUPPLY CURRENT**  
 vs  
**SUPPLY VOLTAGE**  
 ( $T_A = 25^\circ\text{C}$ )

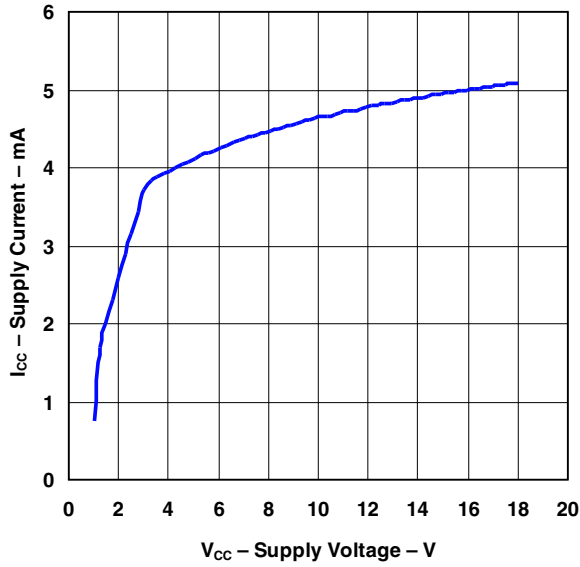

**SUPPLY CURRENT**  
 vs  
**TEMPERATURE**  
 ( $V_{CC} = \pm 15\text{ V}$ )

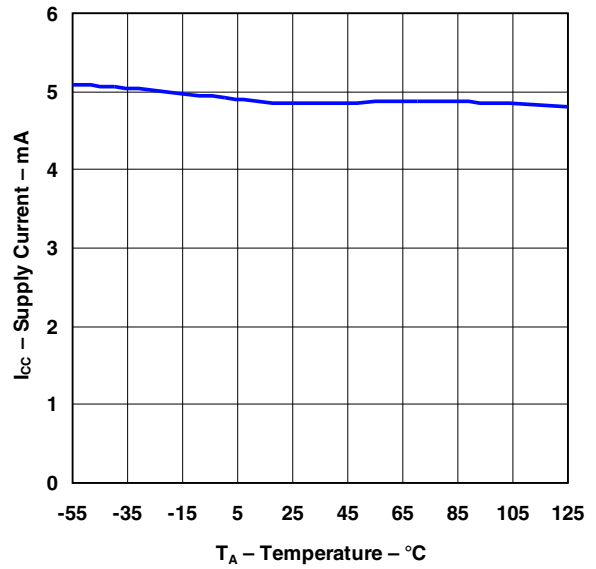

**GAIN AND PHASE**  
 vs  
**FREQUENCY**  
 ( $V_{CC} = \pm 15\text{ V}$ ,  $R_L = 2\text{ k}\Omega$ ,  $C_L = 22\text{ pF}$ )

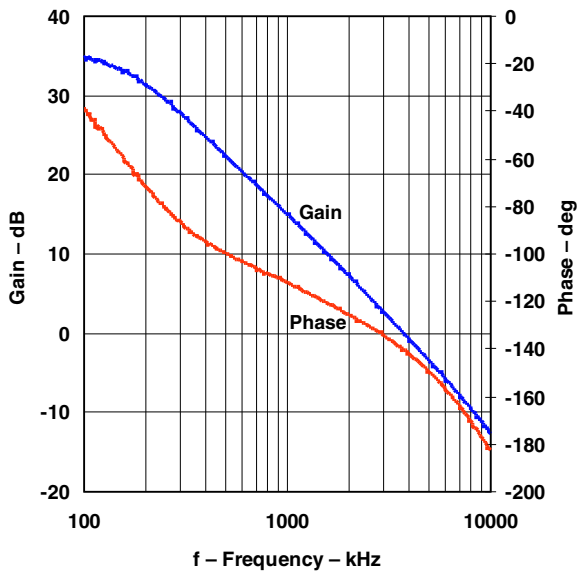

**GAIN AND PHASE**  
 vs  
**FREQUENCY**  
 ( $V_{CC} = \pm 15\text{ V}$ ,  $R_L = 10\text{ k}\Omega$ ,  $C_L = 22\text{ pF}$ )

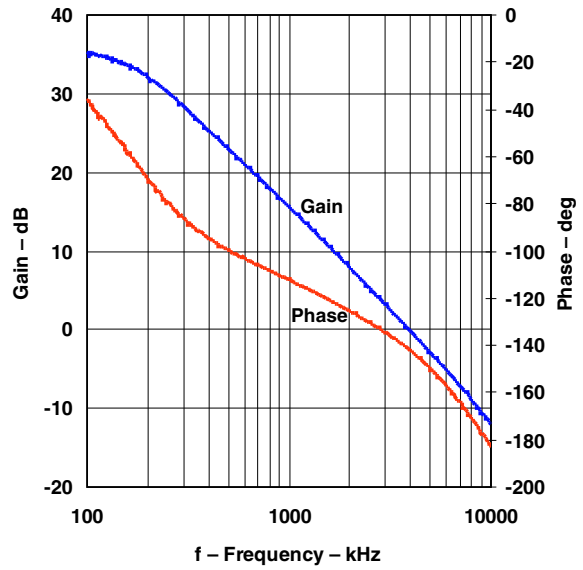

**TYPICAL CHARACTERISTICS (continued)**

**OUTPUT VOLTAGE SWING**  
 VS  
**SUPPLY VOLTAGE**  
 ( $R_L = 2\text{ k}\Omega$ ,  $T_A = 25^\circ\text{C}$ )

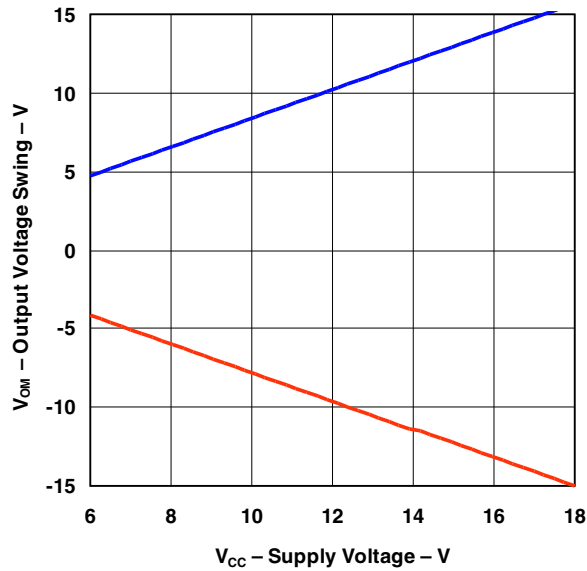

**OUTPUT VOLTAGE SWING**  
 VS  
**FREQUENCY**  
 ( $V_{CC} = \pm 15\text{ V}$ ,  $R_L = 2\text{ k}\Omega$ ,  $T_A = 25^\circ\text{C}$ )

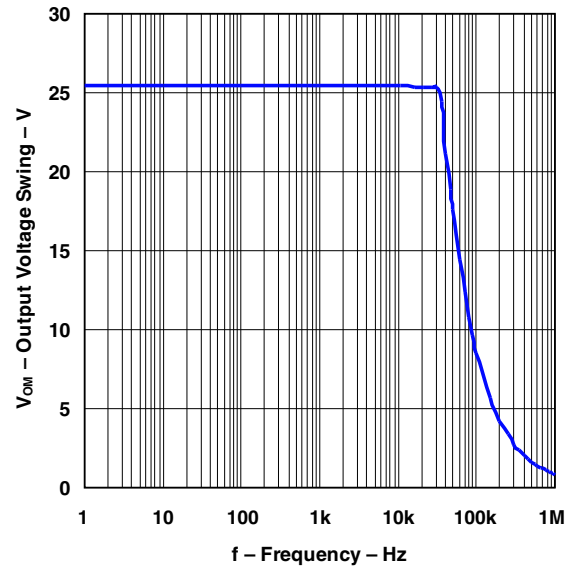

**OUTPUT VOLTAGE SWING**  
 VS  
**LOAD RESISTANCE**  
 ( $V_{CC} = \pm 15\text{ V}$ ,  $T_A = 25^\circ\text{C}$ )

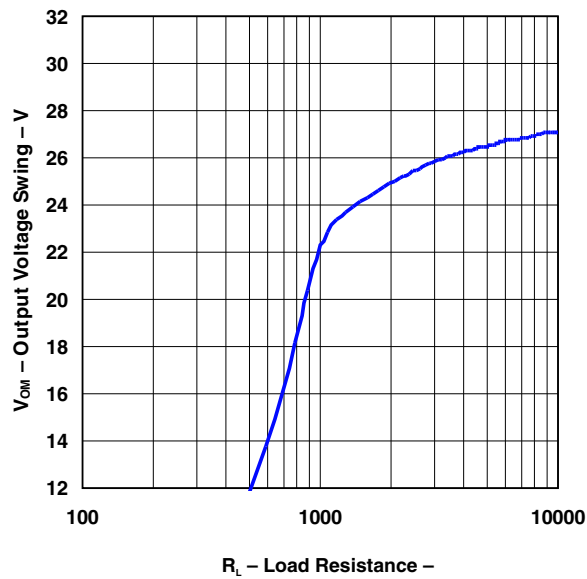

**OUTPUT VOLTAGE SWING**  
 VS  
**TEMPERATURE**  
 ( $V_{CC} = \pm 15\text{ V}$ ,  $R_L = 10\text{ k}\Omega$ )

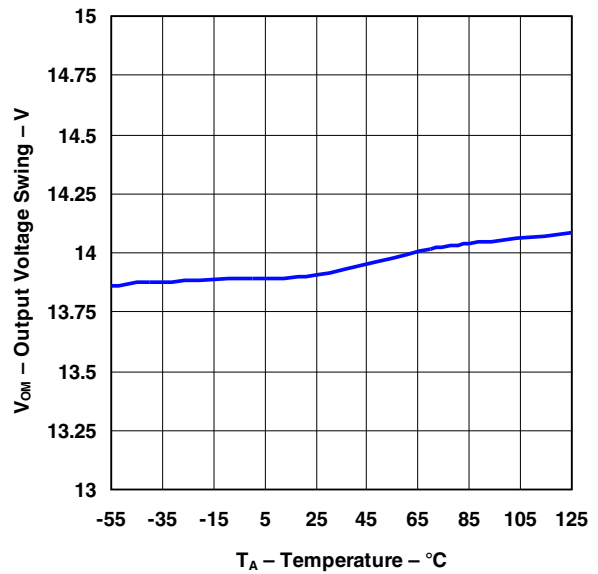

**TYPICAL CHARACTERISTICS (continued)**

**NEGATIVE OUTPUT VOLTAGE SWING**  
**VS**  
**TEMPERATURE**  
 ( $V_{CC} = \pm 15\text{ V}$ ,  $R_L = 10\text{ k}\Omega$ )

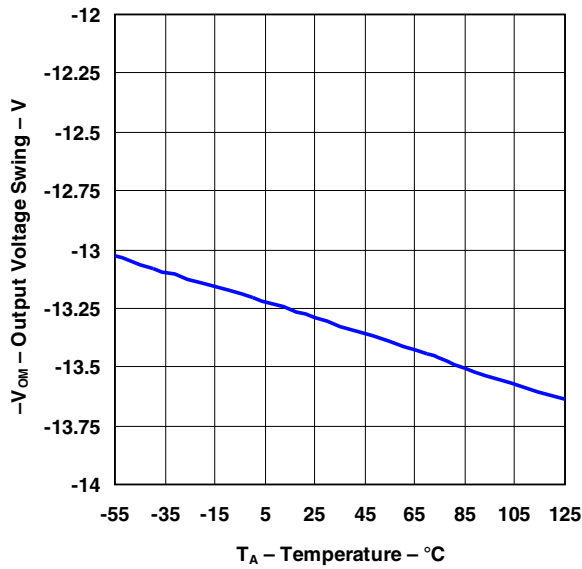

**OPEN LOOP GAIN**  
**VS**  
**FREQUENCY**  
 ( $V_{CC} = \pm 15\text{ V}$ ,  $R_L = 2\text{ k}\Omega$ ,  $C_L = 22\text{ pF}$ ,  $T_A = 25^\circ\text{C}$ )

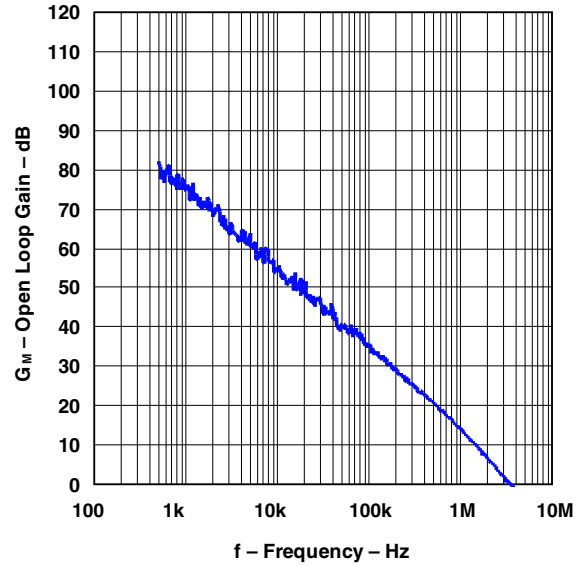

**INPUT BIAS CURRENT**  
**VS**  
**TEMPERATURE**  
 ( $V_{CC} = \pm 15\text{ V}$ )

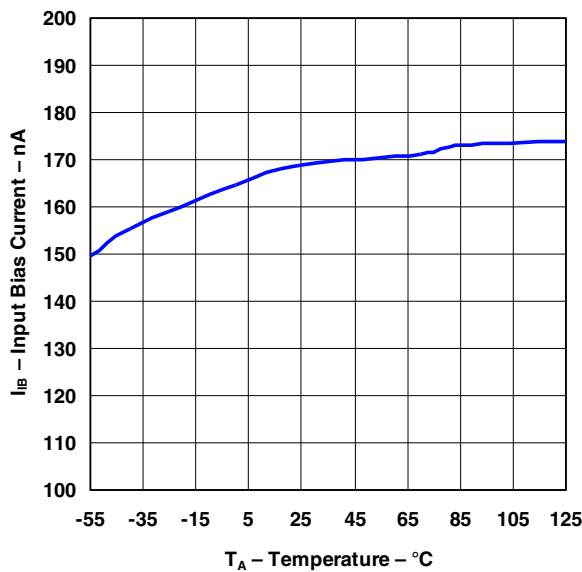

**INPUT OFFSET VOLTAGE**  
**VS**  
**TEMPERATURE**  
 ( $V_{CC} = \pm 15\text{ V}$ )

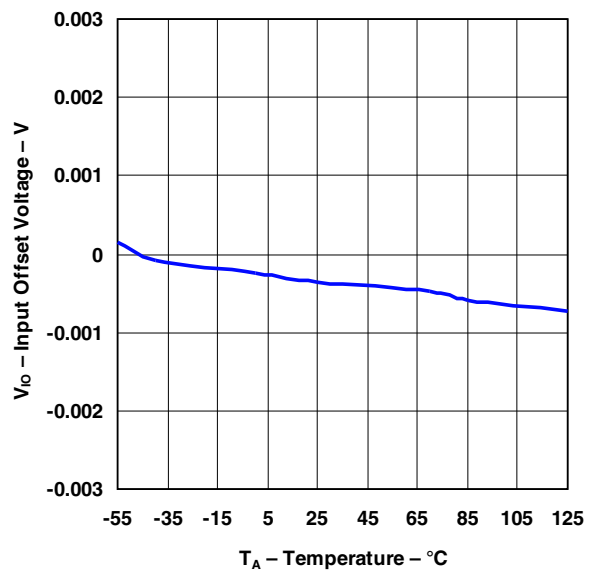

TYPICAL CHARACTERISTICS (continued)

INPUT NOISE VOLTAGE  
VS  
FREQUENCY  
( $V_{CC} = \pm 15\text{ V}$ ,  $T_A = 25^\circ\text{C}$ )

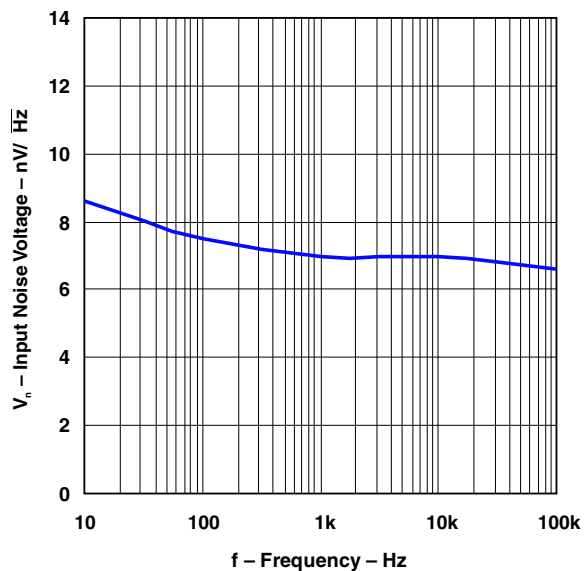



**PACKAGING INFORMATION**

Orderable Device	Status <sup>(1)</sup>	Package Type	Package Drawing	Pins	Package Qty	Eco Plan <sup>(2)</sup>	Lead/ Ball Finish	MSL Peak Temp <sup>(3)</sup>	Samples (Requires Login)
RC4558D	ACTIVE	SOIC	D	8	75	Green (RoHS & no Sb/Br)	CU NIPDAU	Level-1-260C-UNLIM	<a href="#">Purchase Samples</a>
RC4558DE4	ACTIVE	SOIC	D	8	75	Green (RoHS & no Sb/Br)	CU NIPDAU	Level-1-260C-UNLIM	<a href="#">Purchase Samples</a>
RC4558DG4	ACTIVE	SOIC	D	8	75	Green (RoHS & no Sb/Br)	CU NIPDAU	Level-1-260C-UNLIM	<a href="#">Purchase Samples</a>
RC4558DGKR	ACTIVE	MSOP	DGK	8	2500	Green (RoHS & no Sb/Br)	CU NIPDAU	Level-1-260C-UNLIM	Contact TI Distributor or Sales Office
RC4558DGKRG4	ACTIVE	MSOP	DGK	8	2500	Green (RoHS & no Sb/Br)	CU NIPDAU	Level-1-260C-UNLIM	Contact TI Distributor or Sales Office
RC4558DR	ACTIVE	SOIC	D	8	2500	Green (RoHS & no Sb/Br)	CU NIPDAU	Level-1-260C-UNLIM	Contact TI Distributor or Sales Office
RC4558DRE4	ACTIVE	SOIC	D	8	2500	Green (RoHS & no Sb/Br)	CU NIPDAU	Level-1-260C-UNLIM	Contact TI Distributor or Sales Office
RC4558DRG3	PREVIEW	SOIC	D	8	2500	TBD	Call TI	Call TI	Samples Not Available
RC4558DRG4	ACTIVE	SOIC	D	8	2500	Green (RoHS & no Sb/Br)	CU NIPDAU	Level-1-260C-UNLIM	Contact TI Distributor or Sales Office
RC4558ID	ACTIVE	SOIC	D	8	75	Green (RoHS & no Sb/Br)	CU NIPDAU	Level-1-260C-UNLIM	<a href="#">Purchase Samples</a>
RC4558IDE4	ACTIVE	SOIC	D	8	75	Green (RoHS & no Sb/Br)	CU NIPDAU	Level-1-260C-UNLIM	<a href="#">Purchase Samples</a>
RC4558IDG4	ACTIVE	SOIC	D	8	75	Green (RoHS & no Sb/Br)	CU NIPDAU	Level-1-260C-UNLIM	<a href="#">Purchase Samples</a>
RC4558IDGKR	ACTIVE	MSOP	DGK	8	2500	Green (RoHS & no Sb/Br)	CU NIPDAU	Level-1-260C-UNLIM	Contact TI Distributor or Sales Office
RC4558IDGKRG4	ACTIVE	MSOP	DGK	8	2500	Green (RoHS & no Sb/Br)	CU NIPDAU	Level-1-260C-UNLIM	Contact TI Distributor or Sales Office
RC4558IDR	ACTIVE	SOIC	D	8	2500	Green (RoHS & no Sb/Br)	CU NIPDAU	Level-1-260C-UNLIM	Contact TI Distributor or Sales Office
RC4558IDRE4	ACTIVE	SOIC	D	8	2500	Green (RoHS & no Sb/Br)	CU NIPDAU	Level-1-260C-UNLIM	Contact TI Distributor or Sales Office
RC4558IDRG4	ACTIVE	SOIC	D	8	2500	Green (RoHS & no Sb/Br)	CU NIPDAU	Level-1-260C-UNLIM	Contact TI Distributor or Sales Office

Orderable Device	Status <sup>(1)</sup>	Package Type	Package Drawing	Pins	Package Qty	Eco Plan <sup>(2)</sup>	Lead/ Ball Finish	MSL Peak Temp <sup>(3)</sup>	Samples (Requires Login)
RC4558IP	ACTIVE	PDIP	P	8	50	Pb-Free (RoHS)	CU NIPDAU	N / A for Pkg Type	Contact TI Distributor or Sales Office
RC4558IPE4	ACTIVE	PDIP	P	8	50	Pb-Free (RoHS)	CU NIPDAU	N / A for Pkg Type	Contact TI Distributor or Sales Office
RC4558IPW	ACTIVE	TSSOP	PW	8	150	Green (RoHS & no Sb/Br)	CU NIPDAU	Level-1-260C-UNLIM	<a href="#">Purchase Samples</a>
RC4558IPWE4	ACTIVE	TSSOP	PW	8	150	Green (RoHS & no Sb/Br)	CU NIPDAU	Level-1-260C-UNLIM	<a href="#">Purchase Samples</a>
RC4558IPWG4	ACTIVE	TSSOP	PW	8	150	Green (RoHS & no Sb/Br)	CU NIPDAU	Level-1-260C-UNLIM	<a href="#">Purchase Samples</a>
RC4558IPWR	ACTIVE	TSSOP	PW	8	2000	Green (RoHS & no Sb/Br)	CU NIPDAU	Level-1-260C-UNLIM	Contact TI Distributor or Sales Office
RC4558IPWRE4	ACTIVE	TSSOP	PW	8	2000	Green (RoHS & no Sb/Br)	CU NIPDAU	Level-1-260C-UNLIM	Contact TI Distributor or Sales Office
RC4558IPWRG4	ACTIVE	TSSOP	PW	8	2000	Green (RoHS & no Sb/Br)	CU NIPDAU	Level-1-260C-UNLIM	Contact TI Distributor or Sales Office
RC4558P	ACTIVE	PDIP	P	8	50	Pb-Free (RoHS)	CU NIPDAU	N / A for Pkg Type	Contact TI Distributor or Sales Office
RC4558PE4	ACTIVE	PDIP	P	8	50	Pb-Free (RoHS)	CU NIPDAU	N / A for Pkg Type	Contact TI Distributor or Sales Office
RC4558PSLE	OBSOLETE	SO	PS	8		TBD	Call TI	Call TI	Samples Not Available
RC4558PSR	ACTIVE	SO	PS	8	2000	Green (RoHS & no Sb/Br)	CU NIPDAU	Level-1-260C-UNLIM	Contact TI Distributor or Sales Office
RC4558PSRE4	ACTIVE	SO	PS	8	2000	Green (RoHS & no Sb/Br)	CU NIPDAU	Level-1-260C-UNLIM	Contact TI Distributor or Sales Office
RC4558PSRG4	ACTIVE	SO	PS	8	2000	Green (RoHS & no Sb/Br)	CU NIPDAU	Level-1-260C-UNLIM	Contact TI Distributor or Sales Office
RC4558PW	ACTIVE	TSSOP	PW	8	150	Green (RoHS & no Sb/Br)	CU NIPDAU	Level-1-260C-UNLIM	<a href="#">Purchase Samples</a>
RC4558PWE4	ACTIVE	TSSOP	PW	8	150	Green (RoHS & no Sb/Br)	CU NIPDAU	Level-1-260C-UNLIM	<a href="#">Purchase Samples</a>
RC4558PWG4	ACTIVE	TSSOP	PW	8	150	Green (RoHS & no Sb/Br)	CU NIPDAU	Level-1-260C-UNLIM	<a href="#">Purchase Samples</a>
RC4558PWLE	OBSOLETE	TSSOP	PW	8		TBD	Call TI	Call TI	Samples Not Available
RC4558PWR	ACTIVE	TSSOP	PW	8	2000	Green (RoHS & no Sb/Br)	CU NIPDAU	Level-1-260C-UNLIM	Contact TI Distributor or Sales Office

Orderable Device	Status <sup>(1)</sup>	Package Type	Package Drawing	Pins	Package Qty	Eco Plan <sup>(2)</sup>	Lead/ Ball Finish	MSL Peak Temp <sup>(3)</sup>	Samples (Requires Login)
RC4558PWRE4	ACTIVE	TSSOP	PW	8	2000	Green (RoHS & no Sb/Br)	CU NIPDAU	Level-1-260C-UNLIM	Contact TI Distributor or Sales Office
RC4558PWRG4	ACTIVE	TSSOP	PW	8	2000	Green (RoHS & no Sb/Br)	CU NIPDAU	Level-1-260C-UNLIM	Contact TI Distributor or Sales Office
RC4558Y	OBSOLETE	DIESALE	Y	0		TBD	Call TI	Call TI	Samples Not Available

<sup>(1)</sup> The marketing status values are defined as follows:

**ACTIVE:** Product device recommended for new designs.

**LIFEBUY:** TI has announced that the device will be discontinued, and a lifetime-buy period is in effect.

**NRND:** Not recommended for new designs. Device is in production to support existing customers, but TI does not recommend using this part in a new design.

**PREVIEW:** Device has been announced but is not in production. Samples may or may not be available.

**OBSOLETE:** TI has discontinued the production of the device.

<sup>(2)</sup> Eco Plan - The planned eco-friendly classification: Pb-Free (RoHS), Pb-Free (RoHS Exempt), or Green (RoHS & no Sb/Br) - please check <http://www.ti.com/productcontent> for the latest availability information and additional product content details.

**TBD:** The Pb-Free/Green conversion plan has not been defined.

**Pb-Free (RoHS):** TI's terms "Lead-Free" or "Pb-Free" mean semiconductor products that are compatible with the current RoHS requirements for all 6 substances, including the requirement that lead not exceed 0.1% by weight in homogeneous materials. Where designed to be soldered at high temperatures, TI Pb-Free products are suitable for use in specified lead-free processes.

**Pb-Free (RoHS Exempt):** This component has a RoHS exemption for either 1) lead-based flip-chip solder bumps used between the die and package, or 2) lead-based die adhesive used between the die and leadframe. The component is otherwise considered Pb-Free (RoHS compatible) as defined above.

**Green (RoHS & no Sb/Br):** TI defines "Green" to mean Pb-Free (RoHS compatible), and free of Bromine (Br) and Antimony (Sb) based flame retardants (Br or Sb do not exceed 0.1% by weight in homogeneous material)

<sup>(3)</sup> MSL, Peak Temp. -- The Moisture Sensitivity Level rating according to the JEDEC industry standard classifications, and peak solder temperature.

**Important Information and Disclaimer:** The information provided on this page represents TI's knowledge and belief as of the date that it is provided. TI bases its knowledge and belief on information provided by third parties, and makes no representation or warranty as to the accuracy of such information. Efforts are underway to better integrate information from third parties. TI has taken and continues to take reasonable steps to provide representative and accurate information but may not have conducted destructive testing or chemical analysis on incoming materials and chemicals. TI and TI suppliers consider certain information to be proprietary, and thus CAS numbers and other limited information may not be available for release.

In no event shall TI's liability arising out of such information exceed the total purchase price of the TI part(s) at issue in this document sold by TI to Customer on an annual basis.

**TAPE AND REEL INFORMATION**

**QUADRANT ASSIGNMENTS FOR PIN 1 ORIENTATION IN TAPE**

\*All dimensions are nominal

Device	Package Type	Package Drawing	Pins	SPQ	Reel Diameter (mm)	Reel Width W1 (mm)	A0 (mm)	B0 (mm)	K0 (mm)	P1 (mm)	W (mm)	Pin1 Quadrant
RC4558DGKR	MSOP	DGK	8	2500	330.0	12.4	5.3	3.4	1.4	8.0	12.0	Q1
RC4558DR	SOIC	D	8	2500	330.0	12.4	6.4	5.2	2.1	8.0	12.0	Q1
RC4558DR	SOIC	D	8	2500	330.0	12.4	6.4	5.2	2.1	8.0	12.0	Q1
RC4558IDGKR	MSOP	DGK	8	2500	330.0	12.4	5.3	3.4	1.4	8.0	12.0	Q1
RC4558IDR	SOIC	D	8	2500	330.0	12.4	6.4	5.2	2.1	8.0	12.0	Q1
RC4558IPWR	TSSOP	PW	8	2000	330.0	12.4	7.0	3.6	1.6	8.0	12.0	Q1
RC4558PSR	SO	PS	8	2000	330.0	16.4	8.2	6.6	2.5	12.0	16.0	Q1
RC4558PWR	TSSOP	PW	8	2000	330.0	12.4	7.0	3.6	1.6	8.0	12.0	Q1

**TAPE AND REEL BOX DIMENSIONS**

\*All dimensions are nominal

Device	Package Type	Package Drawing	Pins	SPQ	Length (mm)	Width (mm)	Height (mm)
RC4558DGKR	MSOP	DGK	8	2500	358.0	335.0	35.0
RC4558DR	SOIC	D	8	2500	346.0	346.0	29.0
RC4558DR	SOIC	D	8	2500	340.5	338.1	20.6
RC4558IDGKR	MSOP	DGK	8	2500	358.0	335.0	35.0
RC4558IDR	SOIC	D	8	2500	340.5	338.1	20.6
RC4558IPWR	TSSOP	PW	8	2000	346.0	346.0	29.0
RC4558PSR	SO	PS	8	2000	346.0	346.0	33.0
RC4558PWR	TSSOP	PW	8	2000	346.0	346.0	29.0

P (R-PDIP-T8)

PLASTIC DUAL-IN-LINE PACKAGE



- NOTES:
- A. All linear dimensions are in inches (millimeters).
  - B. This drawing is subject to change without notice.
  - C. Falls within JEDEC MS-001 variation BA.

DGK (S-PDSO-G8)

PLASTIC SMALL-OUTLINE PACKAGE

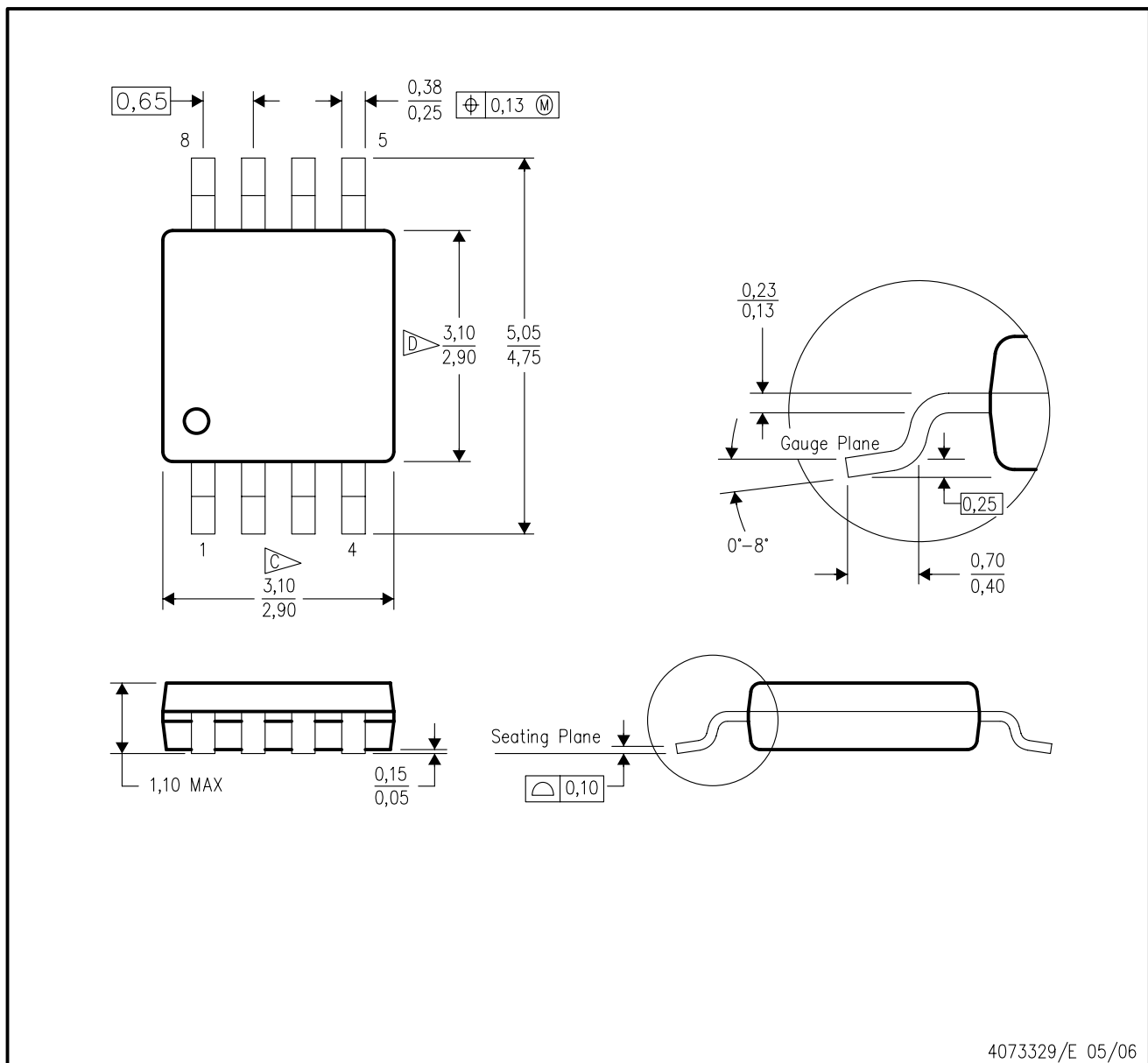

- NOTES:
- A. All linear dimensions are in millimeters.
  - B. This drawing is subject to change without notice.
  - C. Body length does not include mold flash, protrusions, or gate burrs. Mold flash, protrusions, or gate burrs shall not exceed 0.15 per end.
  - D. Body width does not include interlead flash. Interlead flash shall not exceed 0.50 per side.
  - E. Falls within JEDEC MO-187 variation AA, except interlead flash.

D (R-PDSO-G8)

PLASTIC SMALL-OUTLINE PACKAGE

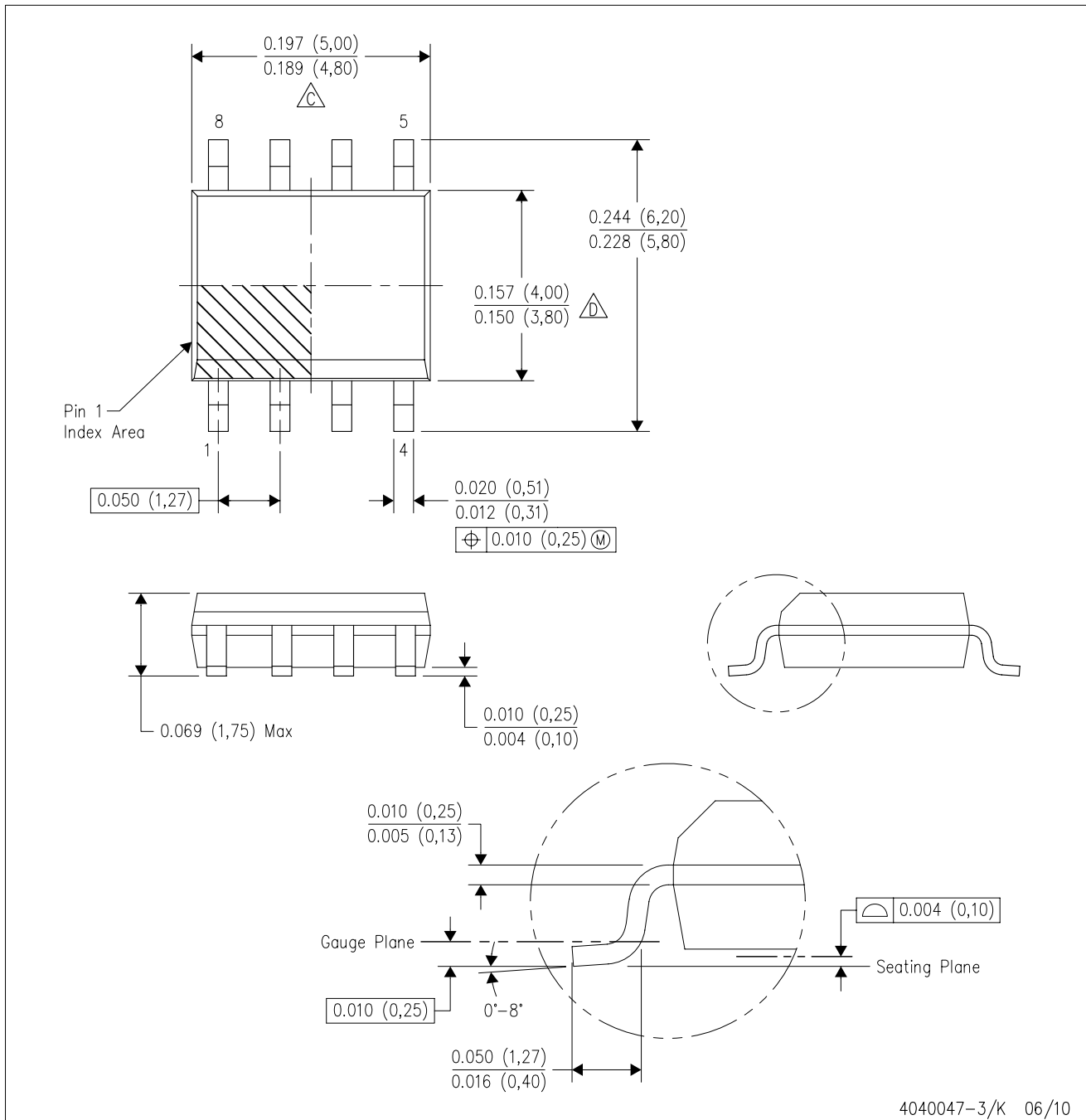

- NOTES:
- A. All linear dimensions are in inches (millimeters).
  - B. This drawing is subject to change without notice.
  - C. Body length does not include mold flash, protrusions, or gate burrs. Mold flash, protrusions, or gate burrs shall not exceed .006 (0,15) per end.
  - D. Body width does not include interlead flash. Interlead flash shall not exceed .017 (0,43) per side.
  - E. Reference JEDEC MS-012 variation AA.





PW (R-PDSO-G\*\*)

PLASTIC SMALL-OUTLINE PACKAGE

14 PINS SHOWN



4040064/F 01/97

- NOTES: A. All linear dimensions are in millimeters.  
 B. This drawing is subject to change without notice.  
 C. Body dimensions do not include mold flash or protrusion not to exceed 0,15.  
 D. Falls within JEDEC MO-153

## IMPORTANT NOTICE

Texas Instruments Incorporated and its subsidiaries (TI) reserve the right to make corrections, modifications, enhancements, improvements, and other changes to its products and services at any time and to discontinue any product or service without notice. Customers should obtain the latest relevant information before placing orders and should verify that such information is current and complete. All products are sold subject to TI's terms and conditions of sale supplied at the time of order acknowledgment.

TI warrants performance of its hardware products to the specifications applicable at the time of sale in accordance with TI's standard warranty. Testing and other quality control techniques are used to the extent TI deems necessary to support this warranty. Except where mandated by government requirements, testing of all parameters of each product is not necessarily performed.

TI assumes no liability for applications assistance or customer product design. Customers are responsible for their products and applications using TI components. To minimize the risks associated with customer products and applications, customers should provide adequate design and operating safeguards.

TI does not warrant or represent that any license, either express or implied, is granted under any TI patent right, copyright, mask work right, or other TI intellectual property right relating to any combination, machine, or process in which TI products or services are used. Information published by TI regarding third-party products or services does not constitute a license from TI to use such products or services or a warranty or endorsement thereof. Use of such information may require a license from a third party under the patents or other intellectual property of the third party, or a license from TI under the patents or other intellectual property of TI.

Reproduction of TI information in TI data books or data sheets is permissible only if reproduction is without alteration and is accompanied by all associated warranties, conditions, limitations, and notices. Reproduction of this information with alteration is an unfair and deceptive business practice. TI is not responsible or liable for such altered documentation. Information of third parties may be subject to additional restrictions.

Resale of TI products or services with statements different from or beyond the parameters stated by TI for that product or service voids all express and any implied warranties for the associated TI product or service and is an unfair and deceptive business practice. TI is not responsible or liable for any such statements.

TI products are not authorized for use in safety-critical applications (such as life support) where a failure of the TI product would reasonably be expected to cause severe personal injury or death, unless officers of the parties have executed an agreement specifically governing such use. Buyers represent that they have all necessary expertise in the safety and regulatory ramifications of their applications, and acknowledge and agree that they are solely responsible for all legal, regulatory and safety-related requirements concerning their products and any use of TI products in such safety-critical applications, notwithstanding any applications-related information or support that may be provided by TI. Further, Buyers must fully indemnify TI and its representatives against any damages arising out of the use of TI products in such safety-critical applications.

TI products are neither designed nor intended for use in military/aerospace applications or environments unless the TI products are specifically designated by TI as military-grade or "enhanced plastic." Only products designated by TI as military-grade meet military specifications. Buyers acknowledge and agree that any such use of TI products which TI has not designated as military-grade is solely at the Buyer's risk, and that they are solely responsible for compliance with all legal and regulatory requirements in connection with such use.

TI products are neither designed nor intended for use in automotive applications or environments unless the specific TI products are designated by TI as compliant with ISO/TS 16949 requirements. Buyers acknowledge and agree that, if they use any non-designated products in automotive applications, TI will not be responsible for any failure to meet such requirements.

Following are URLs where you can obtain information on other Texas Instruments products and application solutions:

<b>Products</b>		<b>Applications</b>	
Amplifiers	<a href="http://amplifier.ti.com">amplifier.ti.com</a>	Audio	<a href="http://www.ti.com/audio">www.ti.com/audio</a>
Data Converters	<a href="http://dataconverter.ti.com">dataconverter.ti.com</a>	Automotive	<a href="http://www.ti.com/automotive">www.ti.com/automotive</a>
DLP® Products	<a href="http://www.dlp.com">www.dlp.com</a>	Communications and Telecom	<a href="http://www.ti.com/communications">www.ti.com/communications</a>
DSP	<a href="http://dsp.ti.com">dsp.ti.com</a>	Computers and Peripherals	<a href="http://www.ti.com/computers">www.ti.com/computers</a>
Clocks and Timers	<a href="http://www.ti.com/clocks">www.ti.com/clocks</a>	Consumer Electronics	<a href="http://www.ti.com/consumer-apps">www.ti.com/consumer-apps</a>
Interface	<a href="http://interface.ti.com">interface.ti.com</a>	Energy	<a href="http://www.ti.com/energy">www.ti.com/energy</a>
Logic	<a href="http://logic.ti.com">logic.ti.com</a>	Industrial	<a href="http://www.ti.com/industrial">www.ti.com/industrial</a>
Power Mgmt	<a href="http://power.ti.com">power.ti.com</a>	Medical	<a href="http://www.ti.com/medical">www.ti.com/medical</a>
Microcontrollers	<a href="http://microcontroller.ti.com">microcontroller.ti.com</a>	Security	<a href="http://www.ti.com/security">www.ti.com/security</a>
RFID	<a href="http://www.ti-rfid.com">www.ti-rfid.com</a>	Space, Avionics & Defense	<a href="http://www.ti.com/space-avionics-defense">www.ti.com/space-avionics-defense</a>
RF/IF and ZigBee® Solutions	<a href="http://www.ti.com/lprf">www.ti.com/lprf</a>	Video and Imaging	<a href="http://www.ti.com/video">www.ti.com/video</a>
		Wireless	<a href="http://www.ti.com/wireless-apps">www.ti.com/wireless-apps</a>

Mailing Address: Texas Instruments, Post Office Box 655303, Dallas, Texas 75265  
Copyright © 2010, Texas Instruments Incorporated