

SN74LS153

Dual 4-Input Multiplexer

The LSTTL/MSI SN74LS153 is a very high speed Dual 4-Input Multiplexer with common select inputs and individual enable inputs for each section. It can select two bits of data from four sources. The two buffered outputs present data in the true (non-inverted) form. In addition to multiplexer operation, the LS153 can generate any two functions of three variables. The LS153 is fabricated with the Schottky barrier diode process for high speed and is completely compatible with all ON Semiconductor TTL families.

- Multifunction Capability
- Non-Inverting Outputs
- Separate Enable for Each Multiplexer
- Input Clamp Diodes Limit High Speed Termination Effects

GUARANTEED OPERATING RANGES

Symbol	Parameter	Min	Typ	Max	Unit
V _{CC}	Supply Voltage	4.75	5.0	5.25	V
T _A	Operating Ambient Temperature Range	0	25	70	°C
I _{OH}	Output Current – High			–0.4	mA
I _{OL}	Output Current – Low			8.0	mA



ON Semiconductor
Formerly a Division of Motorola
<http://onsemi.com>

**LOW
POWER
SCHOTTKY**

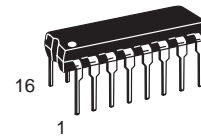

**PLASTIC
N SUFFIX
CASE 648**



**SOIC
D SUFFIX
CASE 751B**

ORDERING INFORMATION

Device	Package	Shipping
SN74LS153N	16 Pin DIP	2000 Units/Box
SN74LS153D	16 Pin	2500/Tape & Reel

SN74LS153

CONNECTION DIAGRAM DIP (TOP VIEW)

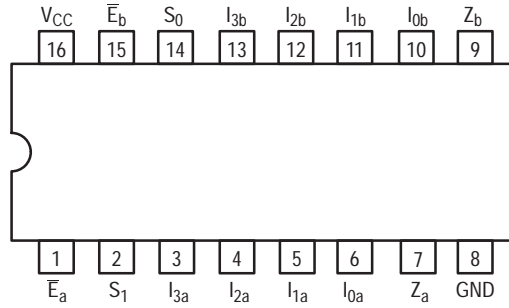

NOTE:
The Flatpak version has the same pinouts (Connection Diagram) as the Dual In-Line Package.

PIN NAMES

S_0	Common Select Input
\bar{E}	Enable (Active LOW) Input
I_0, I_1	Multiplexer Inputs
Z	Multiplexer Output

LOADING (Note a)

	HIGH	LOW
S_0	0.5 U.L.	0.25 U.L.
\bar{E}	0.5 U.L.	0.25 U.L.
I_0, I_1	0.5 U.L.	0.25 U.L.
Z	10 U.L.	5 U.L.

NOTES:

a) 1 TTL Unit Load (U.L.) = 40 μ A HIGH/1.6 mA LOW.

LOGIC SYMBOL

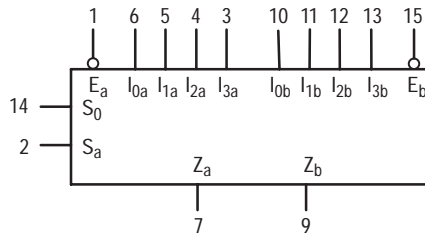

V_{CC} = PIN 16
GND = PIN 8

SN74LS153

LOGIC DIAGRAM

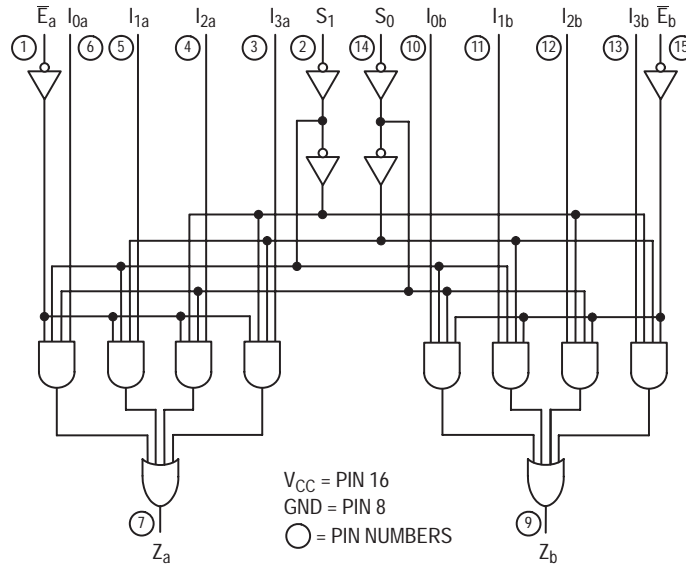

FUNCTIONAL DESCRIPTION

The LS153 is a Dual 4-input Multiplexer fabricated with Low Power, Schottky barrier diode process for high speed. It can select two bits of data from up to four sources under the control of the common Select Inputs (S_0, S_1). The two 4-input multiplexer circuits have individual active LOW Enables (\bar{E}_a, \bar{E}_b) which can be used to strobe the outputs independently. When the Enables (\bar{E}_a, \bar{E}_b) are HIGH, the corresponding outputs (Z_a, Z_b) are forced LOW.

The LS153 is the logic implementation of a 2-pole, 4-position switch, where the position of the switch is determined by the logic levels supplied to the two Select Inputs. The logic equations for the outputs are shown below.

$$Z_a = \bar{E}_a \cdot (I_{0a} \cdot \bar{S}_1 \cdot \bar{S}_0 + I_{1a} \cdot \bar{S}_1 \cdot S_0 + I_{2a} \cdot S_1 \cdot \bar{S}_0 + I_{3a} \cdot S_1 \cdot S_0)$$

$$Z_b = \bar{E}_b \cdot (I_{0b} \cdot \bar{S}_1 \cdot \bar{S}_0 + I_{1b} \cdot \bar{S}_1 \cdot S_0 + I_{2b} \cdot S_1 \cdot \bar{S}_0 + I_{3b} \cdot S_1 \cdot S_0)$$

The LS153 can be used to move data from a group of registers to a common output bus. The particular register from which the data came would be determined by the state of the Select Inputs. A less obvious application is a function generator. The LS153 can generate two functions of three variables. This is useful for implementing highly irregular random logic.

TRUTH TABLE

SELECT INPUTS		INPUTS (a or b)					OUTPUT
S_0	S_1	\bar{E}	I_0	I_1	I_2	I_3	Z
X	X	H	X	X	X	X	L
L	L	L	L	X	X	X	L
L	L	L	H	X	X	X	H
H	L	L	X	L	X	X	L
H	L	L	X	H	X	X	H
L	H	L	X	X	L	X	L
L	H	L	X	X	H	X	H
H	H	L	X	X	X	L	L
H	H	L	X	X	X	H	H

H = HIGH Voltage Level
 L = LOW Voltage Level
 X = Don't Care

SN74LS153

DC CHARACTERISTICS OVER OPERATING TEMPERATURE RANGE (unless otherwise specified)

Symbol	Parameter	Limits			Unit	Test Conditions
		Min	Typ	Max		
V_{IH}	Input HIGH Voltage	2.0			V	Guaranteed Input HIGH Voltage for All Inputs
V_{IL}	Input LOW Voltage			0.8	V	Guaranteed Input LOW Voltage for All Inputs
V_{IK}	Input Clamp Diode Voltage		-0.65	-1.5	V	$V_{CC} = \text{MIN}$, $I_{IN} = -18 \text{ mA}$
V_{OH}	Output HIGH Voltage	2.7	3.5		V	$V_{CC} = \text{MIN}$, $I_{OH} = \text{MAX}$, $V_{IN} = V_{IH}$ or V_{IL} per Truth Table
V_{OL}	Output LOW Voltage		0.25	0.4	V	$I_{OL} = 4.0 \text{ mA}$ $V_{CC} = V_{CC} \text{ MIN}$, $V_{IN} = V_{IL}$ or V_{IH} per Truth Table
			0.35	0.5	V	
I_{IH}	Input HIGH Current			20	μA	$V_{CC} = \text{MAX}$, $V_{IN} = 2.7 \text{ V}$
				0.1	mA	$V_{CC} = \text{MAX}$, $V_{IN} = 7.0 \text{ V}$
I_{IL}	Input LOW Current			-0.4	mA	$V_{CC} = \text{MAX}$, $V_{IN} = 0.4 \text{ V}$
I_{OS}	Short Circuit Current (Note 1)	-20		-100	mA	$V_{CC} = \text{MAX}$
I_{CC}	Power Supply Current			10	mA	$V_{CC} = \text{MAX}$

Note 1: Not more than one output should be shorted at a time, nor for more than 1 second.

AC CHARACTERISTICS ($T_A = 25^\circ\text{C}$)

Symbol	Parameter	Limits			Unit	Test Conditions
		Min	Typ	Max		
t_{PLH} t_{PHL}	Propagation Delay Data to Output		10 17	15 26	ns	Figure 2
t_{PLH} t_{PHL}	Propagation Delay Select to Output		19 25	29 38	ns	Figure 1
t_{PLH} t_{PHL}	Propagation Delay Enable to Output		16 21	24 32	ns	Figure 2

$V_{CC} = 5.0 \text{ V}$
 $C_L = 15 \text{ pF}$

AC WAVEFORMS

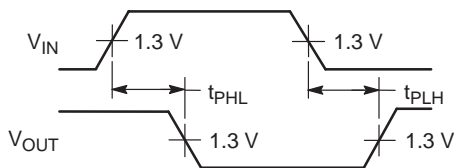

Figure 1.

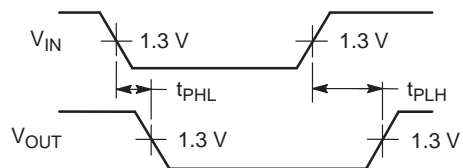
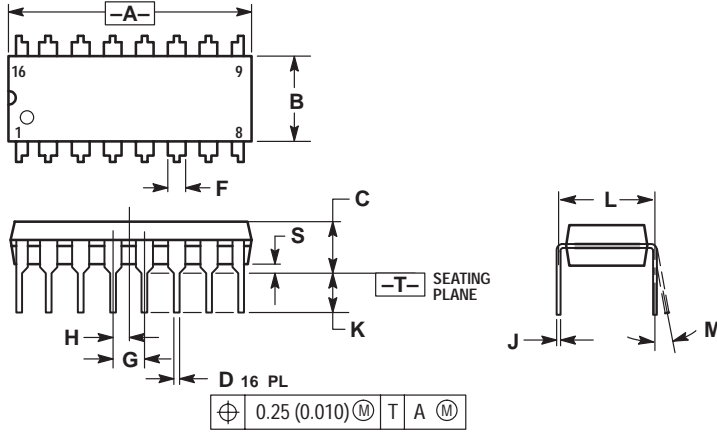

Figure 2.

SN74LS153

PACKAGE DIMENSIONS

N SUFFIX
PLASTIC PACKAGE
CASE 648-08
ISSUE R



NOTES:

1. DIMENSIONING AND TOLERANCING PER ANSI Y14.5M, 1982.
2. CONTROLLING DIMENSION: INCH.
3. DIMENSION L TO CENTER OF LEADS WHEN FORMED PARALLEL.
4. DIMENSION B DOES NOT INCLUDE MOLD FLASH.
5. ROUNDED CORNERS OPTIONAL.

DIM	INCHES		MILLIMETERS	
	MIN	MAX	MIN	MAX
A	0.740	0.770	18.80	19.55
B	0.250	0.270	6.35	6.85
C	0.145	0.175	3.69	4.44
D	0.015	0.021	0.39	0.53
F	0.040	0.70	1.02	1.77
G	0.100 BSC		2.54 BSC	
H	0.050 BSC		1.27 BSC	
J	0.008	0.015	0.21	0.38
K	0.110	0.130	2.80	3.30
L	0.295	0.305	7.50	7.74
M	0° 10°		0° 10°	
S	0.020	0.040	0.51	1.01

SN74LS153

PACKAGE DIMENSIONS

D SUFFIX PLASTIC SOIC PACKAGE CASE 751B-05 ISSUE J



NOTES:

1. DIMENSIONING AND TOLERANCING PER ANSI Y14.5M, 1982.
2. CONTROLLING DIMENSION: MILLIMETER.
3. DIMENSIONS A AND B DO NOT INCLUDE MOLD PROTRUSION.
4. MAXIMUM MOLD PROTRUSION 0.15 (0.006) PER SIDE.
5. DIMENSION D DOES NOT INCLUDE DAMBAR PROTRUSION. ALLOWABLE DAMBAR PROTRUSION SHALL BE 0.127 (0.005) TOTAL IN EXCESS OF THE D DIMENSION AT MAXIMUM MATERIAL CONDITION.

DIM	MILLIMETERS		INCHES	
	MIN	MAX	MIN	MAX
A	9.80	10.00	0.386	0.393
B	3.80	4.00	0.150	0.157
C	1.35	1.75	0.054	0.068
D	0.35	0.49	0.014	0.019
F	0.40	1.25	0.016	0.049
G	1.27 BSC		0.050 BSC	
J	0.19	0.25	0.008	0.009
K	0.10	0.25	0.004	0.009
M	0° 7°		0° 7°	
P	5.80	6.20	0.229	0.244
R	0.25	0.50	0.010	0.019

Notes

ON Semiconductor and  are trademarks of Semiconductor Components Industries, LLC (SCILLC). SCILLC reserves the right to make changes without further notice to any products herein. SCILLC makes no warranty, representation or guarantee regarding the suitability of its products for any particular purpose, nor does SCILLC assume any liability arising out of the application or use of any product or circuit, and specifically disclaims any and all liability, including without limitation special, consequential or incidental damages. "Typical" parameters which may be provided in SCILLC data sheets and/or specifications can and do vary in different applications and actual performance may vary over time. All operating parameters, including "Typicals" must be validated for each customer application by customer's technical experts. SCILLC does not convey any license under its patent rights nor the rights of others. SCILLC products are not designed, intended, or authorized for use as components in systems intended for surgical implant into the body, or other applications intended to support or sustain life, or for any other application in which the failure of the SCILLC product could create a situation where personal injury or death may occur. Should Buyer purchase or use SCILLC products for any such unintended or unauthorized application, Buyer shall indemnify and hold SCILLC and its officers, employees, subsidiaries, affiliates, and distributors harmless against all claims, costs, damages, and expenses, and reasonable attorney fees arising out of, directly or indirectly, any claim of personal injury or death associated with such unintended or unauthorized use, even if such claim alleges that SCILLC was negligent regarding the design or manufacture of the part. SCILLC is an Equal Opportunity/Affirmative Action Employer.

PUBLICATION ORDERING INFORMATION

North America Literature Fulfillment:

Literature Distribution Center for ON Semiconductor
P.O. Box 5163, Denver, Colorado 80217 USA
Phone: 303-675-2175 or 800-344-3860 Toll Free USA/Canada
Fax: 303-675-2176 or 800-344-3867 Toll Free USA/Canada
Email: ONlit@hibbertco.com

N. American Technical Support: 800-282-9855 Toll Free USA/Canada

EUROPE: LDC for ON Semiconductor – European Support

German Phone: (+1) 303-308-7140 (M-F 2:30pm to 5:00pm Munich Time)
Email: ONlit-german@hibbertco.com
French Phone: (+1) 303-308-7141 (M-F 2:30pm to 5:00pm Toulouse Time)
Email: ONlit-french@hibbertco.com
English Phone: (+1) 303-308-7142 (M-F 1:30pm to 5:00pm UK Time)
Email: ONlit@hibbertco.com

ASIA/PACIFIC: LDC for ON Semiconductor – Asia Support

Phone: 303-675-2121 (Tue-Fri 9:00am to 1:00pm, Hong Kong Time)
Toll Free from Hong Kong 800-4422-3781
Email: ONlit-asia@hibbertco.com

JAPAN: ON Semiconductor, Japan Customer Focus Center
4-32-1 Nishi-Gotanda, Shinagawa-ku, Tokyo, Japan 141-8549

Phone: 81-3-5487-8345
Email: r14153@onsemi.com

Fax Response Line: 303-675-2167
800-344-3810 Toll Free USA/Canada

ON Semiconductor Website: <http://onsemi.com>

For additional information, please contact your local
Sales Representative.